**Use:**

Supply and exhaust in low and medium pressure installation in non aggressive environment with relative humidity up to 70%. Recommended for horizontal air supply in rooms up to approximately 4m high.

Assembly:

On rectangular ventilation ducts, in plenum boxes and in ceiling system. Fitted using visible bolts in pressed holes in the front frame or mounted using a central bolt.

Construction:

The front frame and blades are made of rolled, diffusion formed steel sheet profiles. Fixed setting of the blades in the external frame.

Material:

Black steel sheet, galvanized steel, aluminum and stainless steel

Surface finish

RAL 9003 white powder coat or other RAL colour according to RAL catalogue on demand.

Air flow regulation:

With counter directional damper type P without the necessity of dismantling the diffuser, or with a single leaf damper at the SR plenum box inlet

Certificates:

Hygienic certificate: BK/K/0926/01/2018

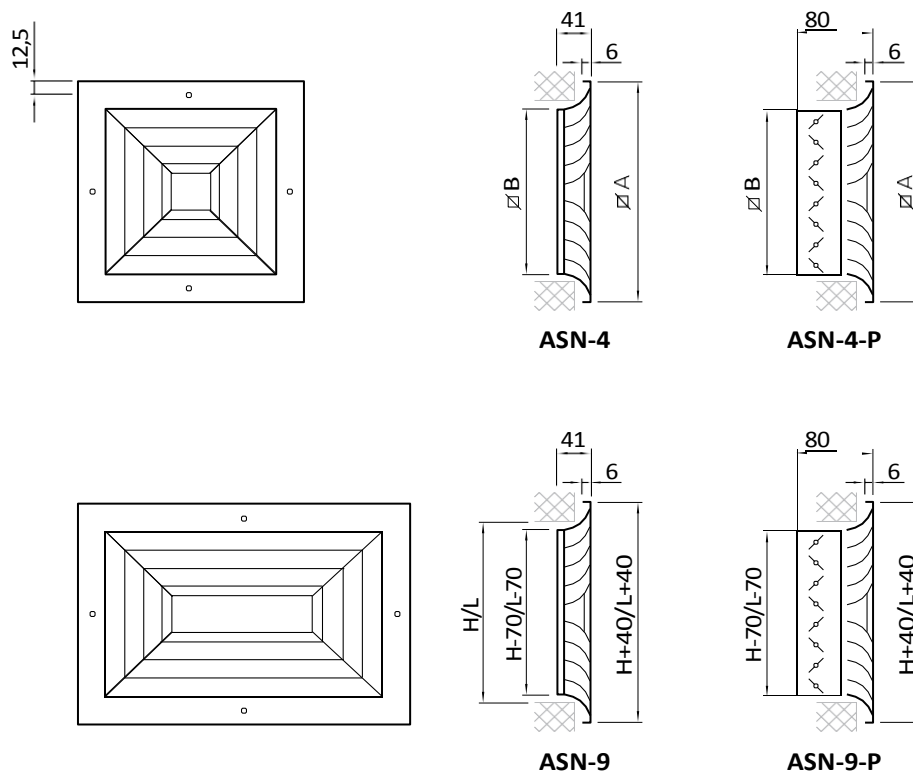
Type and dimension marking:**Products range:**

∅ A [mm]	∅ B [mm]	A [m ²]
190	80	0,0080
245	135	0,0169
301	191	0,0324
357	247	0,0590
412	302	0,0930
469	359	0,1230
498	388	0,1740
595	488	0,2304
623	513	0,2550

Supply diffusers ASN - varianty

ASN-0



ASN-6

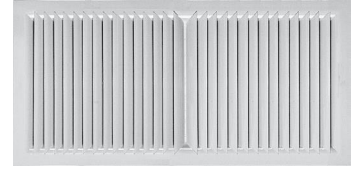

ASN-1



ASN-7

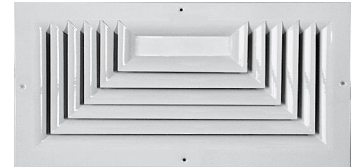

ASN-2



ASN-8

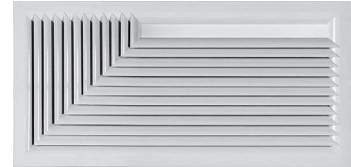

ASN-3



ASN-9

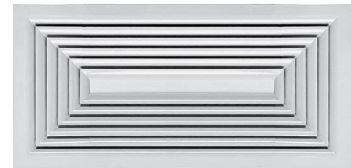

ASN-4



ASN-10

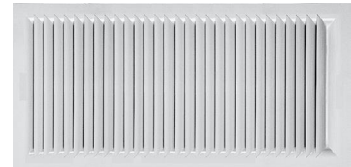

ASN-5



ASN-11



ASN-12

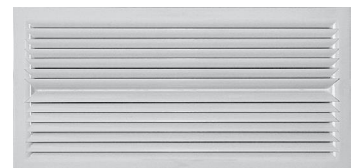

ASN-13

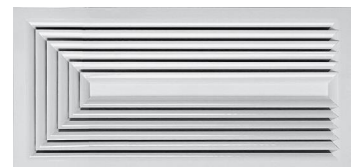

*Diffuser dimensions on demand

Diagram for selection ASN diffusers

Diagram concerns diffusers with fully open dampers.

Range $L_{0,25}$ marks the distance where the air stream velocity does not exceed 0,25 m/s. Velocity V_{gr} marks the maximal adhering air stream velocity at the edge of the diffuser.

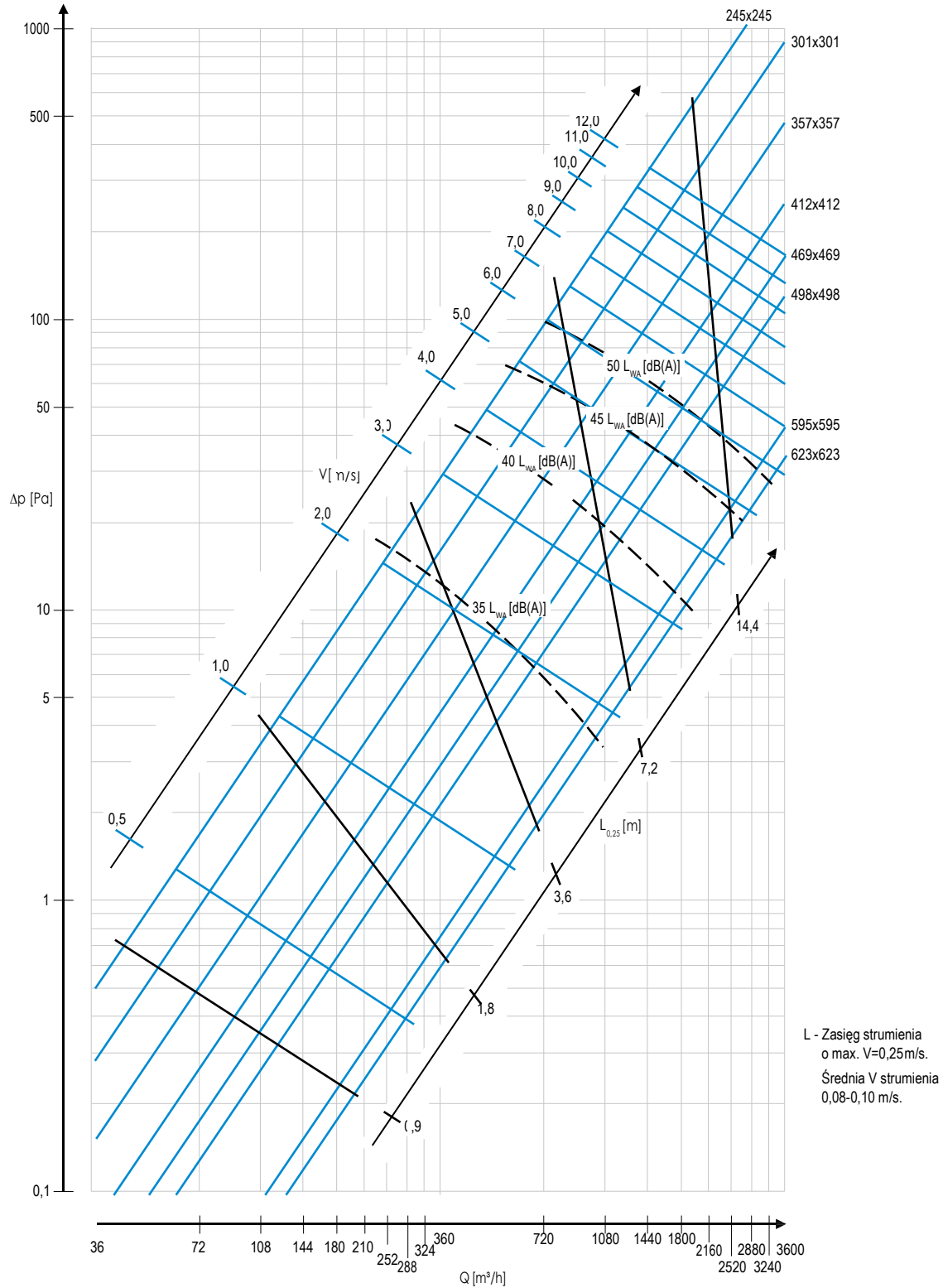

Instruction for selection for ASN diffusers

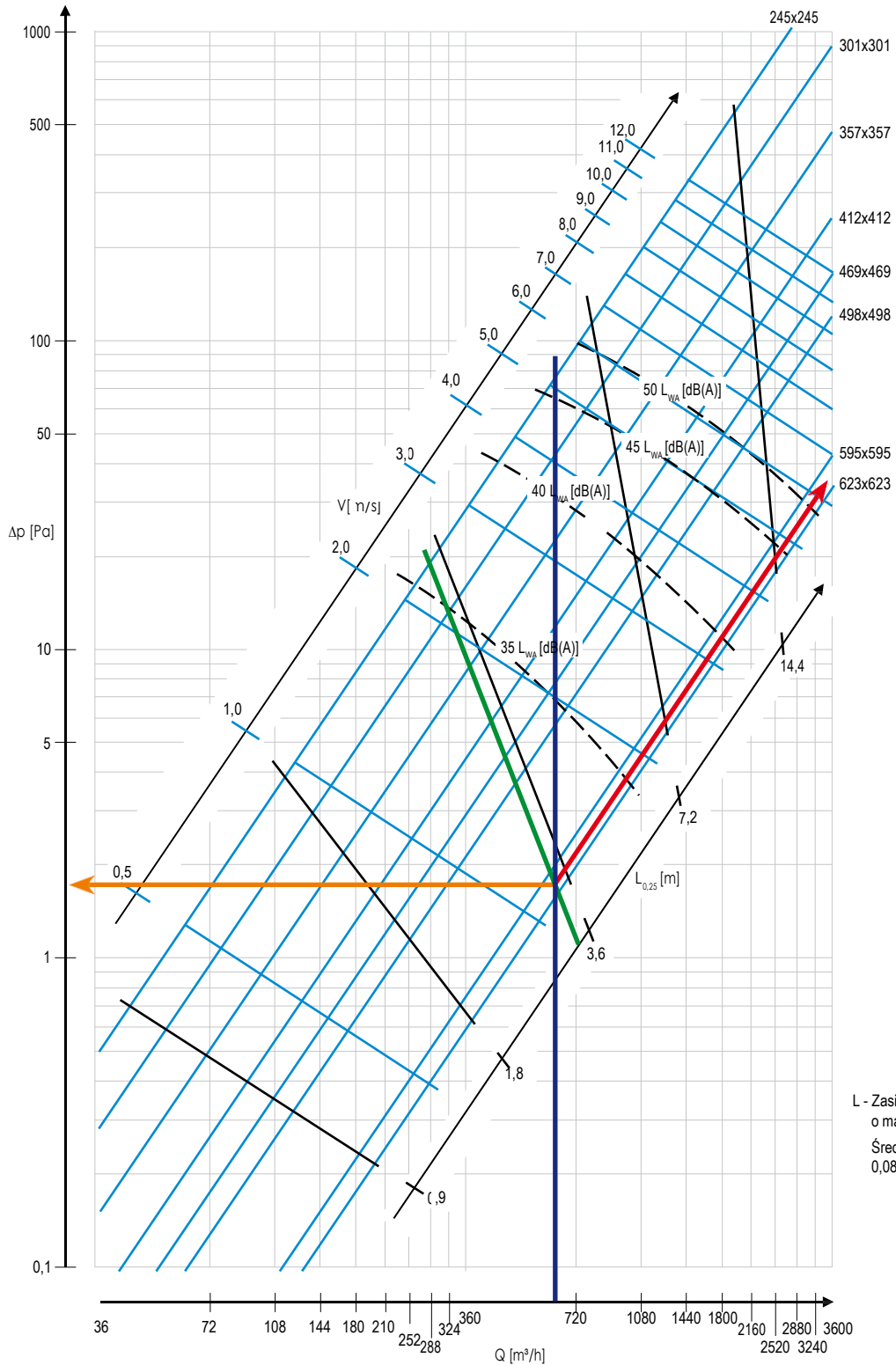

L - Zasięg strumienia
o max. V=0,25m/s.
Średnia V strumienia
0,08-0,10 m/s.

Example (colours adequate to lines):

- Air stream range Q=700 m³/h
- Range L_{0,25} = 3,5 m

Diagram reading:

- Diffuser size 623x623
- Pressure loss: 2 Pa
- Maximum outlet velocity: 1,2 m/s

Chart for choosing ASN diffusers without taking the influence of a wall and a second diffuser into account

Q _v [m³/h]	Q [m³/s]	A _{eff} [m²]									
		Typ	0,0080	0,0169	0,0324	0,0590	0,0930	0,1230	0,1740	0,2304	
			245 x 245	301 x 301	357 x 357	412 x 412	469 x 469	498 x 498	598 x 598	623 x 623	
50	0,014	Δp [Pa] L _{v=0,25} [m] V [m/s] dB	0,9 0,9 0,38 <35	0,5 0,9 0,32 <35	0,3 0,7 0,26 <35						
100	0,028	Δp [Pa] L _{v=0,25} [m] V [m/s] dB	3,0 1,5 0,75 <35	1,7 1,5 0,64 <35	0,9 1,2 0,53 <35	0,5 0,9 0,42 <35	0,3 0,8 0,36 <35	0,2 0,7 0,28 <35			
150	0,042	Δp [Pa] L _{v=0,25} [m] V [m/s] dB	6,1 2,1 1,13 <35	3,5 2,0 0,96 <35	1,8 1,7 0,79 <35	1,0 1,3 0,63 <35	0,6 1,2 0,54 <35	0,5 1,1 0,42 <35	0,2 0,8 0,29 <35		
200	0,056	Δp [Pa] L _{v=0,25} [m] V [m/s] dB	10,2 2,6 1,50 <35	5,7 2,5 1,28 <35	3,0 2,1 1,06 <35	1,6 1,7 0,83 <35	1,0 1,6 0,72 <35	0,8 1,4 0,56 <35	0,3 1,0 0,39 <35	0,2 0,9 0,33 <35	
250	0,069	Δp [Pa] L _{v=0,25} [m] V [m/s] dB	15,0 3,0 1,88 35	8,5 3,0 1,60 <35	4,5 2,5 1,32 <35	2,3 2,1 1,04 <35	1,6 1,9 0,90 <35	1,1 1,7 0,69 <35	0,4 1,3 0,49 <35	0,3 1,1 0,42 <35	
300	0,083	Δp [Pa] L _{v=0,25} [m] V [m/s] dB	20,7 3,5 2,25 <40	11,6 3,4 1,92 35	6,1 2,9 1,58 <35	3,2 2,5 1,25 <35	2,1 2,3 1,08 <35	1,6 2,1 0,83 <35	0,5 1,6 0,58 <35	0,4 1,4 0,50 <35	
400	0,111	Δp [Pa] L _{v=0,25} [m] V [m/s] dB	34,2 4,3 3,00 40	19,2 4,2 2,56 <40	10,2 3,7 2,11 35	5,3 3,2 1,67 <35	3,5 3,0 1,44 <35	2,6 2,7 1,11 <35	0,9 2,2 0,78 <35	0,7 1,9 0,67 <35	
500	0,139	Δp [Pa] L _{v=0,25} [m] V [m/s] dB	50,6 5,1 3,75 <45	28,4 4,9 3,19 <40	15,0 4,3 2,64 <40	7,9 3,9 2,08 35	5,2 3,6 1,81 <35	3,8 3,3 1,39 <35	1,3 2,8 0,97 <35	1,0 2,5 0,83 <35	
600	0,167	Δp [Pa] L _{v=0,25} [m] V [m/s] dB	69,6 5,9 4,50 45	39,1 5,6 3,83 40	20,7 5,0 3,17 <40	10,9 4,5 2,50 <40	7,2 4,3 2,17 <35	5,2 4,0 1,67 <35	1,8 3,4 1,17 <35	1,4 3,1 1,00 <35	
700	0,194	Δp [Pa] L _{v=0,25} [m] V [m/s] dB	91,1 6,6 5,25 <50	51,2 6,2 4,47 <45	27,0 5,7 3,69 40	14,2 5,2 2,92 <40	9,4 4,9 2,53 <40	6,8 4,6 1,94 35	2,4 4,0 1,36 <35	1,9 3,7 1,17 <35	
800	0,222	Δp [Pa] L _{v=0,25} [m] V [m/s] dB	115,1 7,3 6,00 50	64,7 6,9 5,11 45	34,2 6,3 4,22 <45	18,0 5,8 3,33 <40	11,9 5,5 2,89 <40	8,6 5,2 2,22 <40	3,0 4,7 1,56 <35	2,4 4,3 1,33 <35	
900	0,250	Δp [Pa] L _{v=0,25} [m] V [m/s] dB	141,4 8,0 6,75 >50	79,5 7,5 5,75 <50	42,0 6,9 4,75 <45	22,1 6,4 3,75 40	14,6 6,2 3,25 <40	10,6 5,9 2,50 <40	3,7 5,3 1,75 35	2,9 4,9 1,50 <35	
1000	0,278	Δp [Pa] L _{v=0,25} [m] V [m/s] dB	170,1 8,7 7,50 >50	95,7 4,5 6,39 50	50,5 7,5 5,28 45	26,6 7,1 4,17 <45	17,5 6,8 3,61 40	12,8 6,5 2,78 <40	4,5 5,9 1,94 <40	3,5 5,5 1,67 35	
1200	0,333	Δp [Pa] L _{v=0,25} [m] V [m/s] dB	234,0 10,0 9,00 >50	131,6 9,2 7,67 >50	69,5 8,6 6,33 50	36,6 8,3 5,00 <45	24,1 8,0 4,33 <45	17,5 7,7 3,33 40	6,1 7,2 2,33 <40	4,8 6,8 2,00 <40	
1400	0,389	Δp [Pa] L _{v=0,25} [m] V [m/s] dB	306,4 11,2 10,50 >50	172,4 10,3 8,94 >50	91,0 9,7 7,39 >50	47,9 9,5 5,83 45	31,6 9,2 5,06 <45	23,0 9,0 3,89 <45	8,0 8,5 2,72 <40	6,3 8,2 2,33 <40	
1600	0,444	Δp [Pa] L _{v=0,25} [m] V [m/s] dB		217,7 11,3 10,22 >50	114,9 10,8 8,44 >50	60,5 10,6 6,67 50	39,9 10,4 5,78 45	29,0 10,2 4,44 <45	10,2 9,8 3,11 40	8,0 9,5 2,67 <40	
1800	0,500	Δp [Pa] L _{v=0,25} [m] V [m/s] dB			141,2 11,8 9,50 >50	74,3 11,8 7,50 >50	49,1 11,6 6,50 50	35,7 11,4 5,00 45	12,5 11,2 3,50 <45	9,8 10,9 3,00 40	
2000	0,556	Δp [Pa] L _{v=0,25} [m] V [m/s] dB				89,4 12,9 8,33 >50	59,0 12,7 7,22 >50	42,9 12,6 5,56 50	15,0 12,5 3,89 <45	11,8 12,3 3,33 <45	
2400	0,667	Δp [Pa] L _{v=0,25} [m] V [m/s] dB					81,2 15,0 8,67 >50	59,0 15,0 6,67 >50	20,7 15,2 4,67 45	16,2 15,2 4,00 <45	
2800	0,778	Δp [Pa] L _{v=0,25} [m] V [m/s] dB						77,3 17,4 7,78 >50	27,1 18,0 5,44 50	21,3 18,2 4,67 45	
3200	0,889	Δp [Pa] L _{v=0,25} [m] V [m/s] dB						97,6 19,8 8,89 >50	34,2 20,8 6,22 >50	26,9 21,2 5,33 50	
3600	1,000	Δp [Pa] L _{v=0,25} [m] V [m/s] dB							42,0 23,6 7,00 >50	33,0 24,3 6,00 >50	

Uwagi
Tabela dotyczy anemostatów z otwartymi przepustnicami
Wartości podane w tabeli są wartościami przybliżonymi
Straty ciśnienia dotyczą pojedynczego anemostatu

Δp [Pa] - Pressure loss
L_{v=0,25} [m] - odległość przy której prędkość max strumienia nie przekracza 0,25 m/s średnia prędkość strumienia w zakresie 0,08-0,1 m/s
V [m/s] - max prędkość wypływu strumienia przyszanego mierzzonego na brzegu anemostatu
dB - hałas

Stopień przykrycia przepustnicy można w przybliżeniu uwzględnić poprzez współczynnik

stopień zamknięcia	współczynnik
20%	1,2
40%	1,5
60%	3,0
80%	7,0
100%	15,0

Δp_{przepust.} = Δp x współczynnik
L_{v=0,25 przepust.} = L_{v=0,25} / współczynnik

Chart for selection of ASN 245x245 diffusers taking the influence of a wall and a second diffuser into account

Q _h [m ³ /h]	Q [m ³ /s]	Typ	245 x 245	x (odlegość od ściany)				
				1 m	2 m	3 m	4 m	5 m
50	0,014	Δp [Pa]	0,9	L _{pion} (zasięg w pionie)				
		L _{V=0,25} [m]	0,9					
		V [m/s]	0,38					
		dB	<35					
100	0,028	Δp [Pa]	3,0	0,14				
		L _{V=0,25} [m]	1,5					
		V [m/s]	0,75					
		dB	<35					
150	0,042	Δp [Pa]	6,1	0,29				
		L _{V=0,25} [m]	2,1					
		V [m/s]	1,13					
		dB	<35					
200	0,056	Δp [Pa]	10,2	0,43	0,15			
		L _{V=0,25} [m]	2,6					
		V [m/s]	1,50					
		dB	<35					
250	0,069	Δp [Pa]	15,0	0,55	0,29			
		L _{V=0,25} [m]	3,0					
		V [m/s]	1,88					
		dB	35					
300	0,083	Δp [Pa]	20,7	0,68	0,41	0,11		
		L _{V=0,25} [m]	3,5					
		V [m/s]	2,25					
		dB	<40					
400	0,111	Δp [Pa]	34,2	0,91	0,65	0,30	0,05	
		L _{V=0,25} [m]	4,3					
		V [m/s]	3,00					
		dB	40					
500	0,139	Δp [Pa]	50,6	1,12	0,88	0,49	0,17	
		L _{V=0,25} [m]	5,1					
		V [m/s]	3,75					
		dB	<45					
600	0,167	Δp [Pa]	69,6	1,33	1,10	0,66	0,29	0,05
		L _{V=0,25} [m]	5,9					
		V [m/s]	4,50					
		dB	45					
700	0,194	Δp [Pa]	91,1	1,53	1,30	0,83	0,40	0,10
		L _{V=0,25} [m]	6,6					
		V [m/s]	5,25					
		dB	<50					
800	0,222	Δp [Pa]	115,1	1,72	1,50	0,99	0,51	0,15
		L _{V=0,25} [m]	7,3					
		V [m/s]	6,00					
		dB	50					
900	0,250	Δp [Pa]	141,4	1,91	1,70	1,14	0,61	0,20
		L _{V=0,25} [m]	8,0					
		V [m/s]	6,75					
		dB	>50					
1000	0,278	Δp [Pa]	170,1	2,09	1,88	1,30	0,71	0,24
		L _{V=0,25} [m]	8,7					
		V [m/s]	7,50					
		dB	>50					
1200	0,333	Δp [Pa]	234,0	2,44	2,25	1,59	0,91	0,33
		L _{V=0,25} [m]	10,0					
		V [m/s]	9,00					
		dB	>50					

Uwagi

Tabela dotyczy anemostatów z otwartymi przepustnicami
Wartości podane w tabeli są wartościami przybliżonymi
Straty ciśnienia dotyczą pojedynczego anemostatu

- Δp [Pa] - Pressure loss
- L_{V=0,25} [m] - odległość wzdłuż sufitu przy której prędkość max strumienia nie przekracza 0,25 m/s
średnia prędkość strumienia w zakresie 0,08-0,1 m/s
- L_{pion} [m] - odległość pionie od sufitu, przy której prędkość max strumienia nie przekracza 0,25 m/s
średnia prędkość strumienia w zakresie 0,08-0,1 m/s
- x [m] - distance from wall lub połowa odległości między anemostatami
- V [m/s] - max prędkość wypływu strumienia przyssanego mierzonego na brzegu anemostatu
- dB - hałas

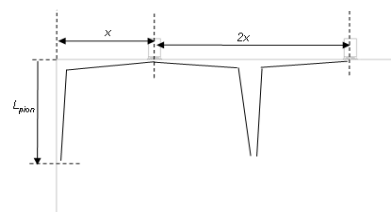

Stopień przymknięcia przepustnicy można w przybliżeniu uwzględnić poprzez współczynnik

stopień zamknięcia	współczynnik
20%	1,2
40%	1,5
60%	3,0
80%	7,0
100%	15,0

- Δp_{przepust.} ≈ Δp x współczynnik
- L_{V=0,25 przepust.} ≈ L_{V=0,25} / współczynnik

Tabela Chart for selection of ASN 301x301 diffusers taking the influence of a wall and a second diffuser into account.

Q _h [m ³ /h]	Q [m ³ /s]	Typ	301 x 301	x (odległość od ściany)				
				1 m	2 m	3 m	4 m	5 m
50	0,014	Δp [Pa]	0,5	L _{pion} (zasięg w pionie)				
		L _{v=0,25} [m]	0,9					
		V [m/s]	0,32					
		dB	<35					
100	0,028	Δp [Pa]	1,7	0,14				
		L _{v=0,25} [m]	1,5					
		V [m/s]	0,64					
		dB	<35					
150	0,042	Δp [Pa]	3,5	0,28				
		L _{v=0,25} [m]	2,0					
		V [m/s]	0,96					
		dB	<35					
200	0,056	Δp [Pa]	5,7	0,41	0,14			
		L _{v=0,25} [m]	2,5					
		V [m/s]	1,28					
		dB	<35					
250	0,069	Δp [Pa]	8,5	0,53	0,26			
		L _{v=0,25} [m]	3,0					
		V [m/s]	1,60					
		dB	<35					
300	0,083	Δp [Pa]	11,6	0,65	0,38	0,08		
		L _{v=0,25} [m]	3,4					
		V [m/s]	1,92					
		dB	35					
400	0,111	Δp [Pa]	19,2	0,86	0,60	0,26	0,02	
		L _{v=0,25} [m]	4,2					
		V [m/s]	2,56					
		dB	<40					
500	0,139	Δp [Pa]	28,4	1,06	0,81	0,43	0,13	
		L _{v=0,25} [m]	4,9					
		V [m/s]	3,19					
		dB	<40					
600	0,167	Δp [Pa]	39,1	1,24	1,00	0,58	0,24	0,03
		L _{v=0,25} [m]	5,6					
		V [m/s]	3,83					
		dB	40					
700	0,194	Δp [Pa]	51,2	1,42	1,19	0,73	0,34	0,08
		L _{v=0,25} [m]	6,2					
		V [m/s]	4,47					
		dB	<45					
800	0,222	Δp [Pa]	64,7	1,59	1,37	0,88	0,43	0,12
		L _{v=0,25} [m]	6,9					
		V [m/s]	5,11					
		dB	45					
900	0,250	Δp [Pa]	79,5	1,76	1,54	1,02	0,53	0,16
		L _{v=0,25} [m]	7,5					
		V [m/s]	5,75					
		dB	<50					
1000	0,278	Δp [Pa]	95,7	0,95	0,69	0,34	0,07	-0,04
		L _{v=0,25} [m]	4,5					
		V [m/s]	6,39					
		dB	50					
1200	0,333	Δp [Pa]	131,6	2,23	2,03	1,41	0,79	0,28
		L _{v=0,25} [m]	9,2					
		V [m/s]	7,67					
		dB	>50					
1400	0,389	Δp [Pa]	172,4	2,52	2,34	1,66	0,95	0,35
		L _{v=0,25} [m]	10,3					
		V [m/s]	8,94					
		dB	>50					

Uwagi

Tabela dotyczy anemostatów z otwartymi przepustnicami
Wartości podane w tabeli są wartościami przybliżonymi
Straty ciśnienia dotyczą pojedynczego anemostatu

Δp [Pa] - Pressure loss

L_{v=0,25} [m] - odległość wzdłuż sufitu przy której prędkość max strumienia nie przekracza 0,25 m/s

średnia prędkość strumienia w zakresie 0,08-0,1 m/s

L_{pion} [m] - odległość pionie od sufitu, przy której prędkość max strumienia nie przekracza 0,25 m/s

średnia prędkość strumienia w zakresie 0,08-0,1 m/s

x [m] - distance from wall lub połowa odległości między anemostatami

V [m/s] - max prędkość wypływu strumienia

przyssanego mierzonego na brzegu anemostatu

dB - hałas

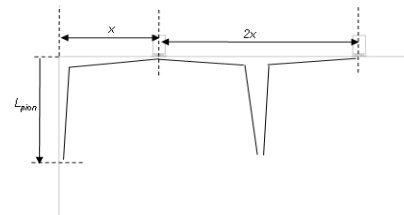

Stopień przymknięcia przepustnicy można w przybliżeniu uwzględnić poprzez współczynnik

stopień zamknięcia	współczynnik
20%	1,2
40%	1,5
60%	3,0
80%	7,0
100%	15,0

Δp_{przepust.} ≈ Δp x współczynnik

L_{v=0,25} przepust. ≈ L_{v=0,25} / współczynnik

Chart for selection of ASN 357x357 diffusers taking the influence of a wall and a second diffuser into account.

Q _h [m ³ /h]	Q [m ³ /s]	Typ	357 x 357	x (odległość od ściany)				
				1 m	2 m	3 m	4 m	5 m
50	0,014	Δp [Pa]	0,3	L _{pion} (zasięg w pionie)				
		L _{v=0,25} [m]	0,7					
		V [m/s]	0,26					
		dB	<35					
100	0,028	Δp [Pa]	0,9	0,07				
		L _{v=0,25} [m]	1,2					
		V [m/s]	0,53					
		dB	<35					
150	0,042	Δp [Pa]	1,8	0,19				
		L _{v=0,25} [m]	1,7					
		V [m/s]	0,79					
		dB	<35					
200	0,056	Δp [Pa]	3,0	0,31	0,03			
		L _{v=0,25} [m]	2,1					
		V [m/s]	1,06					
		dB	<35					
250	0,069	Δp [Pa]	4,5	0,42	0,15			
		L _{v=0,25} [m]	2,5					
		V [m/s]	1,32					
		dB	<35					
300	0,083	Δp [Pa]	6,1	0,52	0,26			
		L _{v=0,25} [m]	2,9					
		V [m/s]	1,58					
		dB	<35					
400	0,111	Δp [Pa]	10,2	0,72	0,46	0,15		
		L _{v=0,25} [m]	3,7					
		V [m/s]	2,11					
		dB	35					
500	0,139	Δp [Pa]	15,0	0,91	0,66	0,31	0,05	
		L _{v=0,25} [m]	4,3					
		V [m/s]	2,64					
		dB	<40					
600	0,167	Δp [Pa]	20,7	1,09	0,85	0,46	0,15	
		L _{v=0,25} [m]	5,0					
		V [m/s]	3,17					
		dB	<40					
700	0,194	Δp [Pa]	27,0	1,27	1,03	0,60	0,25	0,04
		L _{v=0,25} [m]	5,7					
		V [m/s]	3,69					
		dB	40					
800	0,222	Δp [Pa]	34,2	1,43	1,20	0,74	0,34	0,08
		L _{v=0,25} [m]	6,3					
		V [m/s]	4,22					
		dB	<45					
900	0,250	Δp [Pa]	42,0	1,60	1,37	0,88	0,44	0,12
		L _{v=0,25} [m]	6,9					
		V [m/s]	4,75					
		dB	<45					
1000	0,278	Δp [Pa]	50,5	1,76	1,54	1,02	0,53	0,16
		L _{v=0,25} [m]	7,5					
		V [m/s]	5,28					
		dB	45					
1200	0,333	Δp [Pa]	69,5	2,07	1,86	1,27	0,70	0,24
		L _{v=0,25} [m]	8,6					
		V [m/s]	6,33					
		dB	50					
1400	0,389	Δp [Pa]	91,0	2,36	2,17	1,52	0,86	0,31
		L _{v=0,25} [m]	9,7					
		V [m/s]	7,39					
		dB	>50					

Uwagi

Tabela dotyczy anemostatów z otwartymi przepustnicami
Wartości podane w tabeli są wartościami przybliżonymi
Straty ciśnienia dotyczą pojedynczego anemostatu

- Δp [Pa] - Pressure loss
- L_{v=0,25} [m] - odległość wzdłuż sufitu przy której prędkość max strumienia nie przekracza 0,25 m/s
średnia prędkość strumienia w zakresie 0,08-0,1 m/s
- L_{pion} [m] - odległość pionie od sufitu, przy której prędkość max strumienia nie przekracza 0,25 m/s
średnia prędkość strumienia w zakresie 0,08-0,1 m/s
- x [m] - distance from wall lub połowa odległości między anemostatami
- V [m/s] - max prędkość wypływu strumienia przyssanego mierzonego na brzegu anemostatu
- dB - hałas

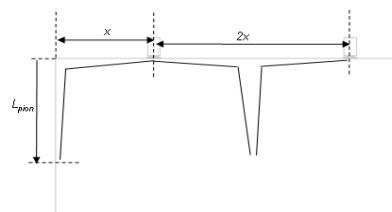

Stopień przymknięcia przepustnicy możliwa w przybliżeniu uwzględnij poprzez współczynnik

stopień zamknięcia	współczynnik
20%	1,2
40%	1,5
60%	3,0
80%	7,0
100%	15,0

Δp_{przepust.} ≈ Δp x współczynnik

L_{v=0,25} przepust. ≈ L_{v=0,25} / współczynnik

Chart for selection of ASN 412x412 diffusers taking the influence of a wall and a second diffuser into account.

Q _h [m ³ /h]	Q [m ³ /s]	Typ	412 x 412	x (odległość od ściany)					
				1 m	2 m	3 m	4 m	5 m	
100	0,028	Δp [Pa] L _{v=0,25} [m] V [m/s] dB	0,5 0,9 0,42 <35	L _{pion} (zasięg w pionie)					
150	0,042	Δp [Pa] L _{v=0,25} [m] V [m/s] dB	1,0 1,3 0,63 <35	0,10					
200	0,056	Δp [Pa] L _{v=0,25} [m] V [m/s] dB	1,6 1,7 0,83 <35	0,20					
250	0,069	Δp [Pa] L _{v=0,25} [m] V [m/s] dB	2,3 2,1 1,04 <35	0,30	0,02				
300	0,083	Δp [Pa] L _{v=0,25} [m] V [m/s] dB	3,2 2,5 1,25 <35	0,40	0,13				
400	0,111	Δp [Pa] L _{v=0,25} [m] V [m/s] dB	5,3 3,2 1,67 <35	0,59	0,33	0,04			
500	0,139	Δp [Pa] L _{v=0,25} [m] V [m/s] dB	7,9 3,9 2,08 35	0,78	0,52	0,20			
600	0,167	Δp [Pa] L _{v=0,25} [m] V [m/s] dB	10,9 4,5 2,50 <40	0,96	0,71	0,35	0,08		
700	0,194	Δp [Pa] L _{v=0,25} [m] V [m/s] dB	14,2 5,2 2,92 <40	1,13	0,89	0,49	0,18	0,01	
800	0,222	Δp [Pa] L _{v=0,25} [m] V [m/s] dB	18,0 5,8 3,33 <40	1,31	1,07	0,64	0,28	0,05	
900	0,250	Δp [Pa] L _{v=0,25} [m] V [m/s] dB	22,1 6,4 3,75 40	1,48	1,25	0,78	0,37	0,09	
1000	0,278	Δp [Pa] L _{v=0,25} [m] V [m/s] dB	26,6 7,1 4,17 <45	1,65	1,42	0,92	0,46	0,13	
1200	0,333	Δp [Pa] L _{v=0,25} [m] V [m/s] dB	36,6 8,3 5,00 <45	1,98	1,77	1,20	0,65	0,21	
1400	0,389	Δp [Pa] L _{v=0,25} [m] V [m/s] dB	47,9 9,5 5,83 45	2,30	2,10	1,47	0,83	0,29	
1600	0,444	Δp [Pa] L _{v=0,25} [m] V [m/s] dB	60,5 10,6 6,67 50	2,62	2,43	1,74	1,01	0,37	

Uwagi

Tabela dotyczy anemostatów z otwartymi przepustnicami
Wartości podane w tabeli są wartościami przybliżonymi
Straty ciśnienia dotyczą pojedynczego anemostatu

Δp [Pa] - Pressure loss

L_{v=0,25} [m] - odległość wzdłuż sufitu przy której prędkość
max strumienia nie przekracza 0,25 m/s

średnia prędkość strumienia w zakresie 0,08-0,1 m/s

L_{pion} [m] - odległość pionie od sufitu, przy której prędkość
max strumienia nie przekracza 0,25 m/s

średnia prędkość strumienia w zakresie 0,08-0,1 m/s

x [m] - distance from wall lub połowa odległości między
anemostatami

V [m/s] - max prędkość wypływu strumienia

przyssanego mierzonego na brzegu anemostatu

dB - hałas

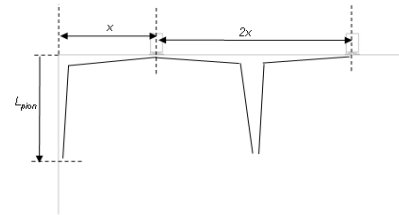

Stopień przymknięcia przepustnicy można
w przybliżeniu uwzględnić poprzez współczynnik

stopień zamknięcia	współczynnik
20%	1,2
40%	1,5
60%	3,0
80%	7,0
100%	15,0

Δp_{przepust.} ≈ Δp x współczynnik

L_{v=0,25} przepust. ≈ L_{v=0,25} / współczynnik

Chart for selection of ASN 469x469 diffusers taking the influence of a wall and a second diffuser into account.

Q _h [m ³ /h]	Q [m ³ /s]	Typ	469 x 469	x (odległość od ściany)					
				1 m	2 m	3 m	4 m	5 m	
100	0,028	Δp [Pa] L _{V=0,25} [m] V [m/s] dB	0,3 0,8 0,36 <35	L _{plon} (zasięg w pionie)					
150	0,042	Δp [Pa] L _{V=0,25} [m] V [m/s] dB	0,6 1,2 0,54 <35	0,06					
200	0,056	Δp [Pa] L _{V=0,25} [m] V [m/s] dB	1,0 1,6 0,72 <35	0,16					
250	0,069	Δp [Pa] L _{V=0,25} [m] V [m/s] dB	1,6 1,9 0,90 <35	0,25					
300	0,083	Δp [Pa] L _{V=0,25} [m] V [m/s] dB	2,1 2,3 1,08 <35	0,35	0,07				
400	0,111	Δp [Pa] L _{V=0,25} [m] V [m/s] dB	3,5 3,0 1,44 <35	0,53	0,26				
500	0,139	Δp [Pa] L _{V=0,25} [m] V [m/s] dB	5,2 3,6 1,81 <35	0,71	0,45	0,14			
600	0,167	Δp [Pa] L _{V=0,25} [m] V [m/s] dB	7,2 4,3 2,17 35	0,89	0,64	0,29	0,04		
700	0,194	Δp [Pa] L _{V=0,25} [m] V [m/s] dB	9,4 4,9 2,53 <40	1,06	0,82	0,43	0,14		
800	0,222	Δp [Pa] L _{V=0,25} [m] V [m/s] dB	11,9 5,5 2,89 <40	1,24	1,00	0,58	0,23	0,03	
900	0,250	Δp [Pa] L _{V=0,25} [m] V [m/s] dB	14,6 6,2 3,25 <40	1,41	1,17	0,72	0,33	0,07	
1000	0,278	Δp [Pa] L _{V=0,25} [m] V [m/s] dB	17,5 6,8 3,61 40	1,57	1,35	0,86	0,42	0,11	
1200	0,333	Δp [Pa] L _{V=0,25} [m] V [m/s] dB	24,1 8,0 4,33 <45	1,91	1,69	1,14	0,61	0,20	
1400	0,389	Δp [Pa] L _{V=0,25} [m] V [m/s] dB	31,6 9,2 5,06 <45	2,23	2,03	1,41	0,79	0,28	
1600	0,444	Δp [Pa] L _{V=0,25} [m] V [m/s] dB	39,9 10,4 5,78 45	2,56	2,37	1,68	0,97	0,36	

Uwagi

Tabela dotyczy anemostatów z otwartymi przepustnicami
Wartości podane w tabeli są wartościami przybliżonymi
Straty ciśnienia dotyczą pojedynczego anemostatu

- Δp [Pa] - Pressure loss
- L_{V=0,25} [m] - odległość wzdłuż sufitu przy której prędkość max strumienia nie przekracza 0,25 m/s
średnia prędkość strumienia w zakresie 0,08-0,1 m/s
- L_{plon} [m] - odległość pionie od sufitu, przy której prędkość max strumienia nie przekracza 0,25 m/s
średnia prędkość strumienia w zakresie 0,08-0,1 m/s
- x [m] - distance from wall lub połowa odległości między anemostatami
- V [m/s] - max prędkość wypływu strumienia przyssanego mierzonego na brzegu anemostatu
- dB - hałas

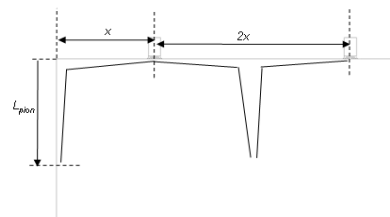

Stopień przymmknięcia przepustnicy można w przybliżeniu uwzględnić poprzez współczynnik

stopień zamknięcia	współczynnik
20%	1,2
40%	1,5
60%	3,0
80%	7,0
100%	15,0

Δp_{przepust.} ≈ Δp x współczynnik

L_{V=0,25} przepust. ≈ L_{V=0,25} / współczynnik

Chart for selection of ASN 498x498 diffusers taking the influence of a wall and a second diffuser into account.

Q _h [m ³ /h]	Q [m ³ /s]	Typ	498 x 498	x (odległość od ściany)					
				1 m	2 m	3 m	4 m	5 m	
100	0,028	Δp [Pa] L _{V=0,25} [m] V [m/s] dB	0,2 0,7 0,28 <35	L _{pion} (zasięg w pionie)					
150	0,042	Δp [Pa] L _{V=0,25} [m] V [m/s] dB	0,5 1,1 0,42 <35	0,02					
200	0,056	Δp [Pa] L _{V=0,25} [m] V [m/s] dB	0,8 1,4 0,56 <35	0,11					
250	0,069	Δp [Pa] L _{V=0,25} [m] V [m/s] dB	1,1 1,7 0,69 <35	0,20					
300	0,083	Δp [Pa] L _{V=0,25} [m] V [m/s] dB	1,6 2,1 0,83 <35	0,29	0,01				
400	0,111	Δp [Pa] L _{V=0,25} [m] V [m/s] dB	2,6 2,7 1,11 <35	0,47	0,19				
500	0,139	Δp [Pa] L _{V=0,25} [m] V [m/s] dB	3,8 3,3 1,39 <35	0,64	0,38	0,08			
600	0,167	Δp [Pa] L _{V=0,25} [m] V [m/s] dB	5,2 4,0 1,67 <35	0,81	0,56	0,23			
700	0,194	Δp [Pa] L _{V=0,25} [m] V [m/s] dB	6,8 4,6 1,94 35	0,99	0,74	0,37	0,09		
800	0,222	Δp [Pa] L _{V=0,25} [m] V [m/s] dB	8,6 5,2 2,22 <40	1,16	0,91	0,51	0,19	0,01	
900	0,250	Δp [Pa] L _{V=0,25} [m] V [m/s] dB	10,6 5,9 2,50 <40	1,33	1,09	0,65	0,29	0,05	
1000	0,278	Δp [Pa] L _{V=0,25} [m] V [m/s] dB	12,8 6,5 2,78 <40	1,50	1,27	0,80	0,38	0,09	
1200	0,333	Δp [Pa] L _{V=0,25} [m] V [m/s] dB	17,5 7,7 3,33 40	1,83	1,62	1,08	0,57	0,18	
1400	0,389	Δp [Pa] L _{V=0,25} [m] V [m/s] dB	23,0 9,0 3,89 <45	2,17	1,96	1,36	0,75	0,26	
1600	0,444	Δp [Pa] L _{V=0,25} [m] V [m/s] dB	29,0 10,2 4,44 <45	2,50	2,31	1,64	0,94	0,34	
1800	0,500	Δp [Pa] L _{V=0,25} [m] V [m/s] dB	35,7 11,4 5,00 45	2,83	2,65	1,91	1,12	0,42	

Uwagi

Tabela dotyczy anemostatów z otwartymi przepustnicami
Wartości podane w tabeli są wartościami przybliżonymi
Straty ciśnienia dotyczą pojedynczego anemostatu

- Δp [Pa] - Pressure loss
L_{V=0,25} [m] - odległość wzdłuż sufitu przy której prędkość max strumienia nie przekracza 0,25 m/s
średnia prędkość strumienia w zakresie 0,08-0,1 m/s
L_{pion} [m] - odległość pionie od sufitu, przy której prędkość max strumienia nie przekracza 0,25 m/s
średnia prędkość strumienia w zakresie 0,08-0,1 m/s
x [m] - distance from wall lub połowa odległości między anemostatami
V [m/s] - max prędkość wypływu strumienia przyszanego mierzonego na brzegu anemostatu
dB - hałas

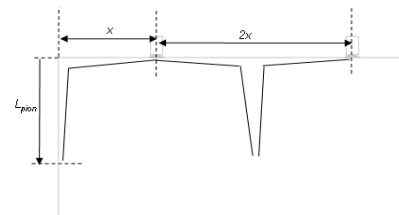

Stopień przymknięcia przepustnicy można w przybliżeniu uwzględnić poprzez współczynnik

stopień zamknięcia	współczynnik
20%	1,2
40%	1,5
60%	3,0
80%	7,0
100%	15,0

Δp_{przepust.} ≈ Δp x współczynnik
L_{V=0,25} przepust. ≈ L_{V=0,25} / współczynnik

Chart for selection of ASN 598x598 diffusers taking the influence of a wall and a second diffuser into account.

Q _h [m ³ /h]	Q [m ³ /s]	Typ	598 x 598	x (odległość od ściany)				
				1 m	2 m	3 m	4 m	5 m
150	0,042	Δp [Pa] L _{V=0,25} [m] V [m/s] dB	0,2 0,8 0,29 <35	L _{pion} (zasięg w pionie)				
200	0,056	Δp [Pa] L _{V=0,25} [m] V [m/s] dB	0,3 1,0 0,39 <35					
250	0,069	Δp [Pa] L _{V=0,25} [m] V [m/s] dB	0,4 1,3 0,49 <35	0,09				
300	0,083	Δp [Pa] L _{V=0,25} [m] V [m/s] dB	0,5 1,6 0,58 <35	0,17				
400	0,111	Δp [Pa] L _{V=0,25} [m] V [m/s] dB	0,9 2,2 0,78 <35	0,33	0,05			
500	0,139	Δp [Pa] L _{V=0,25} [m] V [m/s] dB	1,3 2,8 0,97 <35	0,49	0,22			
600	0,167	Δp [Pa] L _{V=0,25} [m] V [m/s] dB	1,8 3,4 1,17 <35	0,66	0,40	0,10		
700	0,194	Δp [Pa] L _{V=0,25} [m] V [m/s] dB	2,4 4,0 1,36 <35	0,83	0,57	0,24		
800	0,222	Δp [Pa] L _{V=0,25} [m] V [m/s] dB	3,0 4,7 1,56 <35	1,00	0,75	0,38	0,10	
900	0,250	Δp [Pa] L _{V=0,25} [m] V [m/s] dB	3,7 5,3 1,75 35	1,17	0,92	0,52	0,20	0,01
1000	0,278	Δp [Pa] L _{V=0,25} [m] V [m/s] dB	4,5 5,9 1,94 <40	1,34	1,10	0,67	0,29	0,06
1200	0,333	Δp [Pa] L _{V=0,25} [m] V [m/s] dB	6,1 7,2 2,33 <40	1,69	1,47	0,96	0,49	0,14
1400	0,389	Δp [Pa] L _{V=0,25} [m] V [m/s] dB	8,0 8,5 2,72 <40	2,04	1,84	1,26	0,69	0,23
1600	0,444	Δp [Pa] L _{V=0,25} [m] V [m/s] dB	10,2 9,8 3,11 40	2,40	2,21	1,56	0,89	0,32
1800	0,500	Δp [Pa] L _{V=0,25} [m] V [m/s] dB	12,5 11,2 3,50 <45	2,76	2,58	1,86	1,09	0,41

Uwagi

Tabela dotyczy anemostatów z otwartymi przepustnicami
Wartości podane w tabeli są wartościami przybliżonymi
Straty ciśnienia dotyczą pojedynczego anemostatu

- Δp [Pa] - Pressure loss
- L_{V=0,25} [m] - odległość wzdłuż sufitu przy której prędkość max strumienia nie przekracza 0,25 m/s
średnia prędkość strumienia w zakresie 0,08-0,1 m/s
- L_{pion} [m] - odległość pionie od sufitu, przy której prędkość max strumienia nie przekracza 0,25 m/s
średnia prędkość strumienia w zakresie 0,08-0,1 m/s
- x [m] - distance from wall lub połowa odległości między anemostatami
- V [m/s] - max prędkość wypływu strumienia przyssanego mierzonego na brzegu anemostatu
- dB - hałas

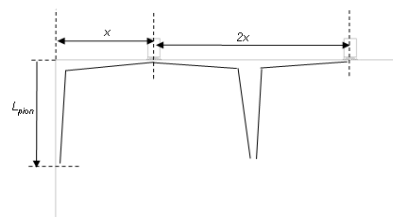

Stopień przymmknięcia przepustnicy moŜna w przybliŜeniu uwzględnic poprzez współczynnik

stopień zamknięcia	współczynnik
20%	1,2
40%	1,5
60%	3,0
80%	7,0
100%	15,0

Δp_{przepust.} ≈ Δp x współczynnik

L_{V=0,25} przepust. ≈ L_{V=0,25} / współczynnik

Chart for selection of ASN 623x623 diffusers taking the influence of a wall and a second diffuser into account.

Q _h [m ³ /h]	Q [m ³ /s]	Typ	623 x 623	x (odległość od ściany)				
				1 m	2 m	3 m	4 m	5 m
200	0,056	Δp [Pa] L _{v=0,25} [m] V [m/s] dB	0,2 0,9 0,33 <35	L _{plon} (zasięg w pionie)				
250	0,069	Δp [Pa] L _{v=0,25} [m] V [m/s] dB	0,3 1,1 0,42 <35					
300	0,083	Δp [Pa] L _{v=0,25} [m] V [m/s] dB	0,4 1,4 0,50 <35	0,11				
400	0,111	Δp [Pa] L _{v=0,25} [m] V [m/s] dB	0,7 1,9 0,67 <35	0,25				
500	0,139	Δp [Pa] L _{v=0,25} [m] V [m/s] dB	1,0 2,5 0,83 <35	0,41	0,13			
600	0,167	Δp [Pa] L _{v=0,25} [m] V [m/s] dB	1,4 3,1 1,00 <35	0,56	0,30	0,02		
700	0,194	Δp [Pa] L _{v=0,25} [m] V [m/s] dB	1,9 3,7 1,17 <35	0,73	0,47	0,15		
800	0,222	Δp [Pa] L _{v=0,25} [m] V [m/s] dB	2,4 4,3 1,33 <35	0,89	0,64	0,29	0,04	
900	0,250	Δp [Pa] L _{v=0,25} [m] V [m/s] dB	2,9 4,9 1,50 <35	1,06	0,82	0,43	0,14	
1000	0,278	Δp [Pa] L _{v=0,25} [m] V [m/s] dB	3,5 5,5 1,67 35	1,24	0,99	0,58	0,23	0,03
1200	0,333	Δp [Pa] L _{v=0,25} [m] V [m/s] dB	4,8 6,8 2,00 <40	1,59	1,36	0,87	0,43	0,12
1400	0,389	Δp [Pa] L _{v=0,25} [m] V [m/s] dB	6,3 8,2 2,33 <40	1,95	1,74	1,18	0,63	0,21
1600	0,444	Δp [Pa] L _{v=0,25} [m] V [m/s] dB	8,0 9,5 2,67 <40	2,32	2,12	1,49	0,84	0,30
1800	0,500	Δp [Pa] L _{v=0,25} [m] V [m/s] dB	9,8 10,9 3,00 40	2,70	2,52	1,80	1,05	0,39

Uwagi

Tabela dotyczy anemostatów z otwartymi przepustnicami
Wartości podane w tabeli są wartościami przybliżonymi
Straty ciśnienia dotyczą pojedynczego anemostatu

- Δp [Pa] - Pressure loss
L_{v=0,25} [m] - odległość wzdłuż sufitu przy której prędkość max strumienia nie przekracza 0,25 m/s
średnia prędkość strumienia w zakresie 0,08-0,1 m/s
L_{plon} [m] - odległość pionie od sufitu, przy której prędkość max strumienia nie przekracza 0,25 m/s
średnia prędkość strumienia w zakresie 0,08-0,1 m/s
x [m] - distance from wall lub połowa odległości między anemostatami
V [m/s] - max prędkość wypływu strumienia przyssanego mierzonego na brzegu anemostatu
dB - hałas

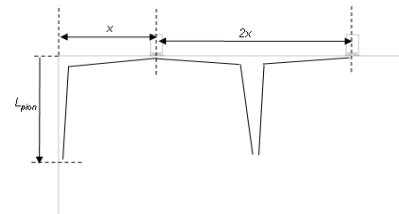

Stopień przymknięcia przepustnicy możliwa w przybliżeniu uwzględnić poprzez współczynnik

stopień zamknięcia	współczynnik
20%	1,2
40%	1,5
60%	3,0
80%	7,0
100%	15,0

Δp_{przepust.} ≈ Δp x współczynnik
L_{v=0,25} przepust. ≈ L_{v=0,25} / współczynnik

Instructions for charts for selection of ASN diffusers taking the influence of a wall and a second diffuser into account

Q _n [m ³ /h]	Q [m ³ /s]	Typ	245 x 245	x (odległość od ściany)				
				1 m	2 m	3 m	4 m	5 m
50	0.014	Δp [Pa]	0.9	L _{plon} (zasieg w pionie)				
		L _{v=0.25} [m]	0.9					
100	0.028	Δp [Pa]	3.0	0.14				
		L _{v=0.25} [m]	1.5					
150	0.042	Δp [Pa]	6.1	0.29				
		L _{v=0.25} [m]	2.1					
200	0.056	Δp [Pa]	10.2	0.43	0.15			
		L _{v=0.25} [m]	2.6					
250	0.069	Δp [Pa]	15.0	0.55	0.29			
		L _{v=0.25} [m]	3.0					
300	0.083	Δp [Pa]	20.7	0.68	0.41	0.11		
		L _{v=0.25} [m]	3.5					
400	0.111	Δp [Pa]	34.2	0.91	0.65	0.30	0.05	
		L _{v=0.25} [m]	4.3					
500	0.139	Δp [Pa]	50.6	1.12	0.88	0.49	0.17	
		L _{v=0.25} [m]	5.1					
600	0.167	Δp [Pa]	69.6	1.33	1.10	0.66	0.29	0.05
		L _{v=0.25} [m]	5.9					
700	0.194	Δp [Pa]	91.1	1.53	1.30	0.83	0.40	0.10
		L _{v=0.25} [m]	6.6					
800	0.222	Δp [Pa]	115.1	1.72	1.50	0.99	0.51	0.15
		L _{v=0.25} [m]	7.3					
900	0.250	Δp [Pa]	141.4	1.91	1.70	1.14	0.61	0.20
		L _{v=0.25} [m]	8.0					
1000	0.278	Δp [Pa]	170.1	2.09	1.88	1.30	0.71	0.24
		L _{v=0.25} [m]	8.7					
1200	0.333	Δp [Pa]	234.0	2.44	2.25	1.59	0.91	0.33
		L _{v=0.25} [m]	10.0					

Uwagi

Tabela dotyczy anemostatów z otwartymi przepustnicami
Wartości podane w tabeli są wartościami przybliżonymi
Straty ciśnienia dotyczą pojedynczego anemostatu

- Δp [Pa] - Pressure loss
- L_{v=0.25} [m] - odległość wzdłuż sufitu przy której prędkość max strumienia nie przekracza 0,25 m/s
średnia prędkość strumienia w zakresie 0,08-0,1 m/s
- L_{plon} [m] - odległość pionie od sufitu, przy której prędkość max strumienia nie przekracza 0,25 m/s
średnia prędkość strumienia w zakresie 0,08-0,1 m/s
- x [m] - distance from wall lub połowa odległości między anemostatami
- V [m/s] - max prędkość wypływu strumienia
przyssanego mierzonego na brzegu anemostatu
- dB - hałas

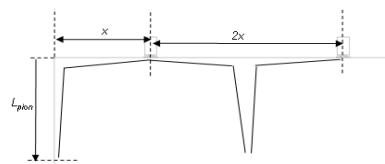

Example:

1) Single diffuser without wall influence, e.g.
For Q
h = 700 m³/h it has the range of 6,6m for a stream of 0,2m/s velocity

2) Taking into account the influence of a wall 3m from the diffuser we get:
Range along the ceiling - 6.6m,
Vertical range along the wall is 0.83m from the ceiling (summary 3m + 83m = 3,83m)

3). Having two diffusers e.g. 6 meters from each other and looking for the stream range between them, one has to divide the distance between them by 2 (in this case it will be 3m) and read the diagram as when taking into account the influence of a wall 3m from the diffuser

Part of the basic diagram concerning air distribution along the ceiling taking the influence on the wall into account

Part taking into account the influence of a wall and a second diffuser on the range

Chart for selection rectangular diffusers ASN-10, ASN-11

Dimensions L x H [mm]	Maximum stream velocity (v_{ef}) [m/s]	1,5	2,0	2,5	3,0	3,5
	Pressure loss (Δp) [Pa]	9	15	23	33	43
372 x 205	Air stream volume (Q) [m ³ /h]	216	288	360	432	504
	Level of accustic power L_{WA} = [dB(A)]	–	–	28	33	38
472 x 208	Air stream volume (Q) [m ³ /h]	286	382	477	572	668
	Level of accustic power L_{WA} = [dB(A)]	–	–	29	34	39
572 x 208	Air stream volume (Q) [m ³ /h]	362	482	603	724	844
	Level of accustic power L_{WA} = [dB(A)]	–	–	30	35	40
672 x 208	Air stream volume (Q) [m ³ /h]	432	576	720	864	1008
	Level of accustic power L_{WA} = [dB(A)]	–	26	31	36	41
872 x 208	Air stream volume (Q) [m ³ /h]	578	770	963	1156	1348
	Level of accustic power L_{WA} = [dB(A)]	–	26	32	37	42
1072 x 208	Air stream volume (Q) [m ³ /h]	724	965	1206	1448	1688
	Level of accustic power L_{WA} = [dB(A)]	–	27	33	38	43
1272 x 208	Air stream volume (Q) [m ³ /h]	864	1152	1440	1728	2016
	Level of accustic power L_{WA} = [dB(A)]	–	29	35	41	45
472 x 261	Air stream volume (Q) [m ³ /h]	405	540	675	810	945
	Level of accustic power L_{WA} = [dB(A)]	–	–	30	35	40
572 x 261	Air stream volume (Q) [m ³ /h]	508	677	846	1015	1184
	Level of accustic power L_{WA} = [dB(A)]	–	–	31	36	41
672 x 261	Air stream volume (Q) [m ³ /h]	610	814	1017	1220	1424
	Level of accustic power L_{WA} = [dB(A)]	–	26	32	37	42
872 x 261	Air stream volume (Q) [m ³ /h]	815	1087	1359	1631	1903
	Level of accustic power L_{WA} = [dB(A)]	–	27	33	39	43
572 x 317	Air stream volume (Q) [m ³ /h]	659	878	1098	1318	1537
	Level of accustic power L_{WA} = [dB(A)]	–	26	32	37	42
672 x 317	Air stream volume (Q) [m ³ /h]	794	1058	1323	1588	1852
	Level of accustic power L_{WA} = [dB(A)]	–	27	33	39	43

Chart for selection rectangular diffusers ASN-6, ASN-12

Dimensions L x H [mm]	Maximum stream velocity (V_{ef}) [m/s]	1,5	2,0	2,5	3,0	3,5
	Pressure loss (Δp) [Pa]	9	15	23	33	43
372 x 205	Air stream volume (Q) [m ³ /h]	216	288	360	432	504
	Level of accustic power L_{WA} = [dB(A)]	–	–	28	33	38
472 x 208	Air stream volume (Q) [m ³ /h]	286	382	477	572	668
	Level of accustic power L_{WA} = [dB(A)]	–	–	29	34	39
572 x 208	Air stream volume (Q) [m ³ /h]	362	482	603	724	844
	Level of accustic power L_{WA} = [dB(A)]	–	–	30	35	40
672 x 208	Air stream volume (Q) [m ³ /h]	432	576	720	864	1008
	Level of accustic power L_{WA} = [dB(A)]	–	26	31	36	41
872 x 208	Air stream volume (Q) [m ³ /h]	578	770	963	1156	1348
	Level of accustic power L_{WA} = [dB(A)]	–	26	32	37	42
1072 x 208	Air stream volume (Q) [m ³ /h]	724	965	1206	1448	1688
	Level of accustic power L_{WA} = [dB(A)]	–	27	33	38	43
1272 x 208	Air stream volume (Q) [m ³ /h]	864	1152	1440	1728	2016
	Level of accustic power L_{WA} = [dB(A)]	–	29	35	41	45
472 x 261	Air stream volume (Q) [m ³ /h]	405	540	675	810	945
	Level of accustic power L_{WA} = [dB(A)]	–	–	30	35	40
572 x 261	Air stream volume (Q) [m ³ /h]	508	677	846	1015	1184
	Level of accustic power L_{WA} = [dB(A)]	–	–	31	36	41
672 x 261	Air stream volume (Q) [m ³ /h]	610	814	1017	1220	1424
	Level of accustic power L_{WA} = [dB(A)]	–	26	32	37	42
872 x 261	Air stream volume (Q) [m ³ /h]	815	1087	1359	1631	1903
	Level of accustic power L_{WA} = [dB(A)]	–	27	33	39	43
1072 x 261	Air stream volume (Q) [m ³ /h]	1021	1361	1701	2041	2381
	Level of accustic power L_{WA} = [dB(A)]	–	28	34	39	43
1272 x 261	Air stream volume (Q) [m ³ /h]	1226	1634	2043	2452	2860
	Level of accustic power L_{WA} = [dB(A)]	26	29	35	41	45
572 x 317	Air stream volume (Q) [m ³ /h]	659	878	1098	1318	1537
	Level of accustic power L_{WA} = [dB(A)]	–	26	32	37	42
672 x 317	Air stream volume (Q) [m ³ /h]	794	1058	1323	1588	1852
	Level of accustic power L_{WA} = [dB(A)]	–	27	33	39	43
872 x 317	Air stream volume (Q) [m ³ /h]	1058	1411	1764	2117	2470
	Level of accustic power L_{WA} = [dB(A)]	–	28	34	40	44
1072 x 317	Air stream volume (Q) [m ³ /h]	1323	1764	2205	2646	3087
	Level of accustic power L_{WA} = [dB(A)]	26	29	35	41	45
1272 x 317	Air stream volume (Q) [m ³ /h]	1588	2117	2646	3175	3704
	Level of accustic power L_{WA} = [dB(A)]	31	36	40	44	49
672 x 372	Air stream volume (Q) [m ³ /h]	972	1296	1620	1944	2268
	Level of accustic power L_{WA} = [dB(A)]	–	27	33	28	42
872 x 372	Air stream volume (Q) [m ³ /h]	1301	1735	2169	2603	3037
	Level of accustic power L_{WA} = [dB(A)]	26	29	35	41	45
1072 x 372	Air stream volume (Q) [m ³ /h]	1625	2167	2709	3251	3793
	Level of accustic power L_{WA} = [dB(A)]	31	36	40	44	49
872 x 372	Air stream volume (Q) [m ³ /h]	2539	2052	2565	3078	3591
	Level of accustic power L_{WA} = [dB(A)]	30	35	39	44	48

Chart for selection rectangular diffusers ASN-9

Dimensions L x H [mm]	Maximum stream velocity (V_{gr}) [m/s]	1,5	2,0	2,5	3,0	3,5
	Pressure loss (Δp) [Pa]	9	15	23	33	43
372 x 205	Air stream volume (Q) [m ³ /h]	216	288	360	432	504
	Level of accustic power L_{WA} = [dB(A)]	–	–	28	33	38
472 x 208	Air stream volume (Q) [m ³ /h]	286	382	477	572	668
	Level of accustic power L_{WA} = [dB(A)]	–	–	29	34	39
572 x 208	Air stream volume (Q) [m ³ /h]	362	482	603	724	844
	Level of accustic power L_{WA} = [dB(A)]	–	–	30	35	40
672 x 208	Air stream volume (Q) [m ³ /h]	432	576	720	864	1008
	Level of accustic power L_{WA} = [dB(A)]	–	26	31	36	41
872 x 208	Air stream volume (Q) [m ³ /h]	578	770	963	1156	1348
	Level of accustic power L_{WA} = [dB(A)]	–	26	32	37	42
1072 x 208	Air stream volume (Q) [m ³ /h]	724	965	1206	1448	1688
	Level of accustic power L_{WA} = [dB(A)]	–	27	33	38	43
1272 x 208	Air stream volume (Q) [m ³ /h]	864	1152	1440	1728	2016
	Level of accustic power L_{WA} = [dB(A)]	–	29	35	41	45
472 x 261	Air stream volume (Q) [m ³ /h]	405	540	675	810	945
	Level of accustic power L_{WA} = [dB(A)]	–	–	30	35	40
572 x 261	Air stream volume (Q) [m ³ /h]	508	677	846	1015	1184
	Level of accustic power L_{WA} = [dB(A)]	–	–	31	36	41
672 x 261	Air stream volume (Q) [m ³ /h]	610	814	1017	1220	1424
	Level of accustic power L_{WA} = [dB(A)]	–	26	32	37	42
872 x 261	Air stream volume (Q) [m ³ /h]	815	1087	1359	1631	1903
	Level of accustic power L_{WA} = [dB(A)]	–	27	33	39	43
1072 x 261	Air stream volume (Q) [m ³ /h]	1021	1361	1701	2041	2381
	Level of accustic power L_{WA} = [dB(A)]	–	28	34	39	43
1272 x 261	Air stream volume (Q) [m ³ /h]	1226	1634	2043	2452	2860
	Level of accustic power L_{WA} = [dB(A)]	26	29	35	41	45
572 x 317	Air stream volume (Q) [m ³ /h]	659	878	1098	1318	1537
	Level of accustic power L_{WA} = [dB(A)]	–	26	32	37	42
672 x 317	Air stream volume (Q) [m ³ /h]	794	1058	1323	1588	1852
	Level of accustic power L_{WA} = [dB(A)]	–	27	33	39	43
872 x 317	Air stream volume (Q) [m ³ /h]	1058	1411	1764	2117	2470
	Level of accustic power L_{WA} = [dB(A)]	–	28	34	40	44
1072 x 317	Air stream volume (Q) [m ³ /h]	1323	1764	2205	2646	3087
	Level of accustic power L_{WA} = [dB(A)]	26	29	35	41	45
1272 x 317	Air stream volume (Q) [m ³ /h]	1588	2117	2646	3175	3704
	Level of accustic power L_{WA} = [dB(A)]	31	36	40	44	49
672 x 372	Air stream volume (Q) [m ³ /h]	972	1296	1620	1944	2268
	Level of accustic power L_{WA} = [dB(A)]	–	27	33	38	42
872 x 372	Air stream volume (Q) [m ³ /h]	1301	1735	2169	2603	3037
	Level of accustic power L_{WA} = [dB(A)]	26	29	35	41	45
1072 x 372	Air stream volume (Q) [m ³ /h]	1625	2167	2709	3251	3793
	Level of accustic power L_{WA} = [dB(A)]	31	36	40	44	49
1272 x 372	Air stream volume (Q) [m ³ /h]	1949	2599	3249	3899	4549
	Level of accustic power L_{WA} = [dB(A)]	33	39	44	47	52
872 x 429	Air stream volume (Q) [m ³ /h]	1539	2052	2565	3078	3591
	Level of accustic power L_{WA} = [dB(A)]	30	35	39	44	48
1072 x 429	Air stream volume (Q) [m ³ /h]	1928	2570	3213	3856	4498
	Level of accustic power L_{WA} = [dB(A)]	33	39	44	47	51
1272 x 429	Air stream volume (Q) [m ³ /h]	2317	3089	3861	4633	5405
	Level of accustic power L_{WA} = [dB(A)]	35	41	46	51	54
972 x 458	Air stream volume (Q) [m ³ /h]	1863	2484	3105	3726	4347
	Level of accustic power L_{WA} = [dB(A)]	32	38	43	46	51
1172 x 558	Air stream volume (Q) [m ³ /h]	2867	3823	4779	5735	6691
	Level of accustic power L_{WA} = [dB(A)]	36	43	48	54	57
1222 x 583	Air stream volume (Q) [m ³ /h]	3154	4205	5256	6307	7358
	Level of accustic power L_{WA} = [dB(A)]	37	44	50	55	58

Chart for selection rectangular diffusers ASN-7, ASN-8, ASN-13

Dimensions L x H [mm]	Maximum stream velocity (V_{eff}) [m/s]	1,5	2,0	2,5	3,0	3,5
	Pressure loss (Δp) [Pa]	9	15	23	33	43
372 x 205	Air stream volume (Q) [m ³ /h]	216	288	360	432	504
	Level of accustic power L_{WA} = [dB(A)]	–	–	28	33	38
472 x 208	Air stream volume (Q) [m ³ /h]	286	382	477	572	668
	Level of accustic power L_{WA} = [dB(A)]	–	–	29	34	39
572 x 208	Air stream volume (Q) [m ³ /h]	362	482	603	724	844
	Level of accustic power L_{WA} = [dB(A)]	–	–	30	35	40
672 x 208	Air stream volume (Q) [m ³ /h]	432	576	720	864	1008
	Level of accustic power L_{WA} = [dB(A)]	–	26	31	36	41
472 x 261	Air stream volume (Q) [m ³ /h]	405	540	675	810	945
	Level of accustic power L_{WA} = [dB(A)]	–	–	30	35	40
572 x 261	Air stream volume (Q) [m ³ /h]	508	677	846	1015	1184
	Level of accustic power L_{WA} = [dB(A)]	–	–	31	36	41
672 x 261	Air stream volume (Q) [m ³ /h]	610	814	1017	1220	1424
	Level of accustic power L_{WA} = [dB(A)]	–	26	32	37	42
872 x 261	Air stream volume (Q) [m ³ /h]	815	1087	1359	1631	1903
	Level of accustic power L_{WA} = [dB(A)]	–	27	33	39	43
572 x 317	Air stream volume (Q) [m ³ /h]	659	878	1098	1318	1537
	Level of accustic power L_{WA} = [dB(A)]	–	26	32	37	42
672 x 317	Air stream volume (Q) [m ³ /h]	794	1058	1323	1588	1852
	Level of accustic power L_{WA} = [dB(A)]	–	27	33	39	43
872 x 317	Air stream volume (Q) [m ³ /h]	1058	1411	1764	2117	2470
	Level of accustic power L_{WA} = [dB(A)]	–	28	34	40	44
672 x 372	Air stream volume (Q) [m ³ /h]	972	1296	1620	1944	2268
	Level of accustic power L_{WA} = [dB(A)]	–	27	33	38	42
872 x 372	Air stream volume (Q) [m ³ /h]	1301	1735	2169	2603	3037
	Level of accustic power L_{WA} = [dB(A)]	26	29	35	41	45
872 x 458	Air stream volume (Q) [m ³ /h]	1539	2052	2565	3078	3591
	Level of accustic power L_{WA} = [dB(A)]	30	35	39	44	48
972 x 458	Air stream volume (Q) [m ³ /h]	1863	2484	3105	3726	4347
	Level of accustic power L_{WA} = [dB(A)]	32	38	43	46	51

Product Marking ASN

ASN-AL-4-P-595×595-RAL-SR/Ø-WMC

	<p>Assembly: Standard – visible screws WMC – central screw B – without holes</p>
	<p>Plenum box / diameter: SR – plenum box SRP – plenum box with damper SRPw – plenum box with damper regulation inside SRIP – plenum box with damper and isolation SRIPw – plenum box with damper regulation inside and isoation Z – additional mounting elements</p>
	<p>Surface finish: Standard – RAL 9003</p>
	<p>Dimensions: External dimensions A – Diffusers ASN External dimension np. A/K – Ceiling system ASN-K</p>
	<p>Air flow regulation: P – galv. Steel damper P al. – aluminium damper P ko – stainless steel damper</p>
	<p>Air flow direction: Standard – 4 (4-ways)</p>
	<p>Material: Standard – black steel painted RAL 9003 alp – aluminium painted in Ral colour oc – galvanized steel ocp – galvaznied steel painted RAL colour ko – stainless steel</p>
	<p>Type of diffusers</p>

Example:

ASN-4-P-595×595-SR/Ø160-WMC

4-ways diffuser with damper P. Dimensions 595x595, standard RAL 9003, plenum box with diameter Ø160, central screw.

If one does not write all details RDJ Klima will make standard one.